

AT89C51/52 Programmer
 revised by Chin-Shiuh Shieh 2000/03/27

RS232 Connector

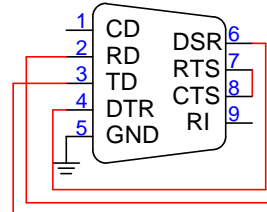

ICL232

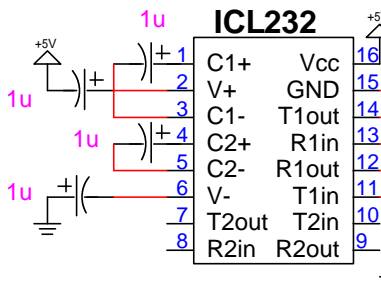

RESET

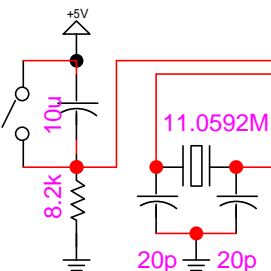

**EZ52.HEX
AT89C51**

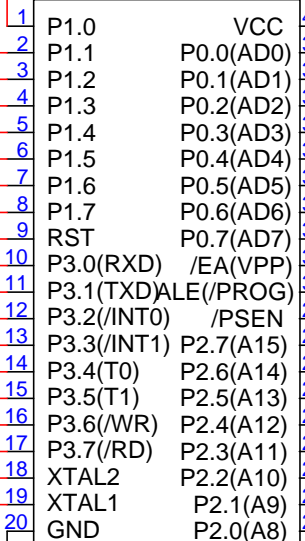

**40-PIN ZIF
AT89C51**

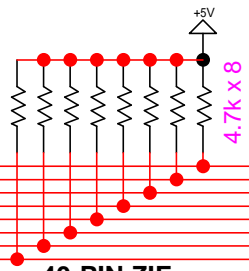
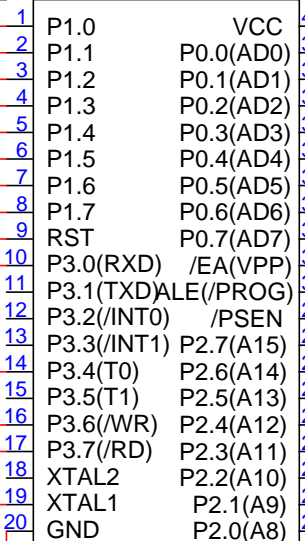

7805

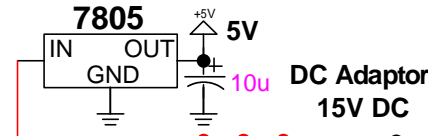

LM317L

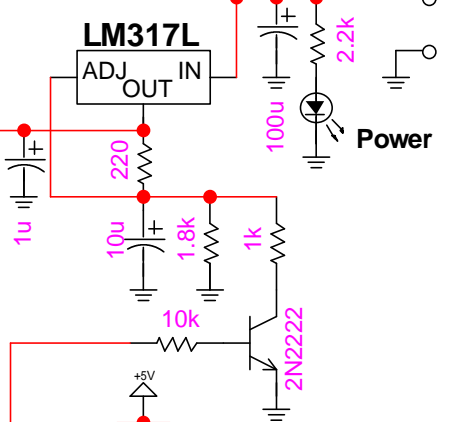

Erase Program

